

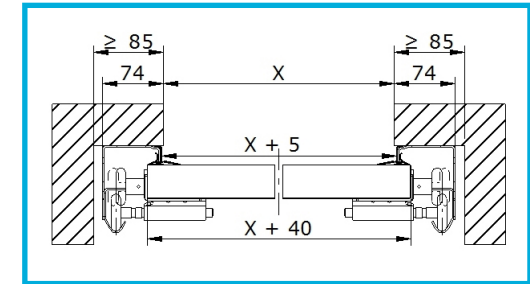

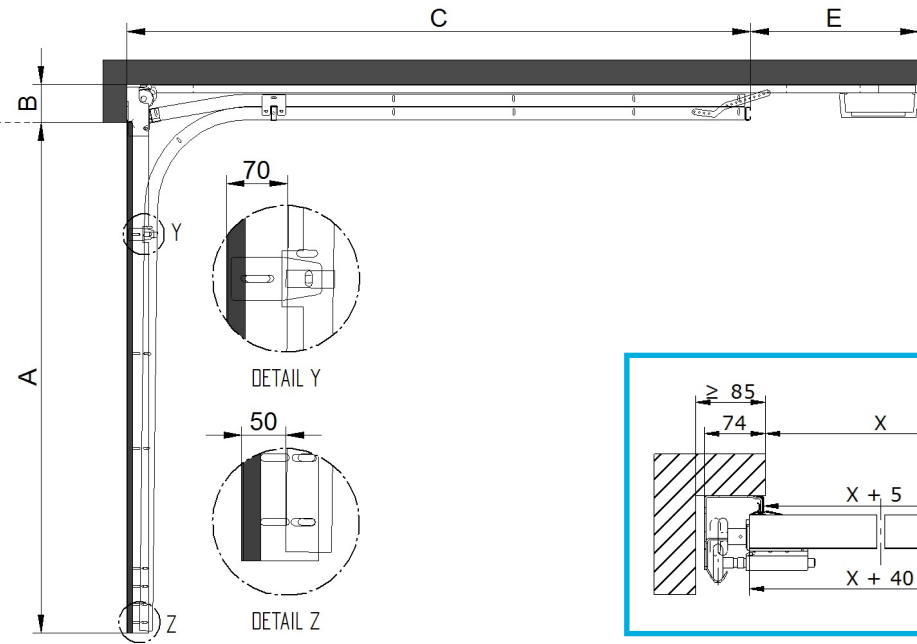
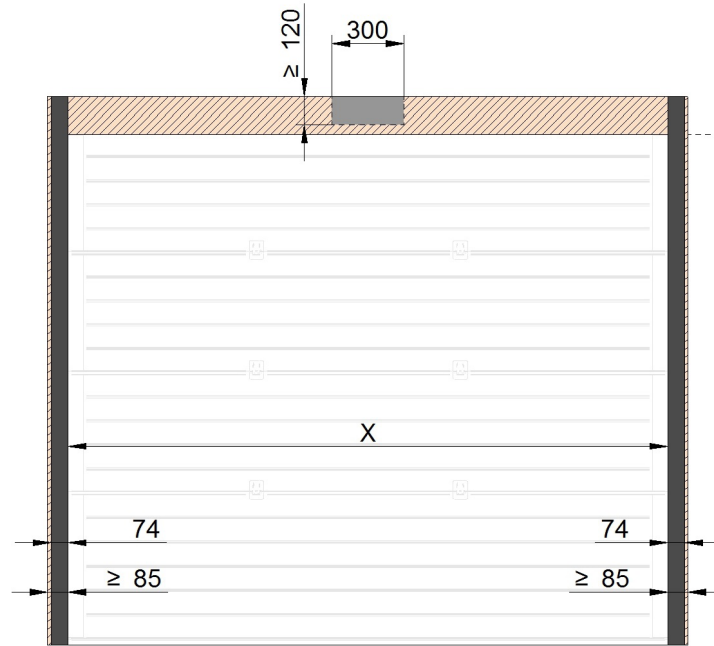

Surface de montage
Espace necessaire
Rail moteur au linteau

A	Hauteur de baie	$\leq 3000\text{mm}$
B	Linteau disponible	$\geq 200\text{mm}$
C	Recul	
E	Espace necessaire pour moteur	
G	Poids de la porte	$\leq 300\text{kg}$
W	Surface de la porte	$\leq 18\text{m}^2$
X	Largeur de baie	$\leq 6000\text{mm}$

	C	C + E
	2605 mm (A > 2000 - 2125 mm)	3325 mm
	2730 mm (A > 2125 - 2250 mm)	3575 mm
	2855 mm (A > 2250 - 2375 mm)	3575 mm
	2980 mm (A > 2375 - 2500 mm)	4335 mm
	3230 mm (A > 2500 - 2750 mm)	4335 mm
	3480 mm (A > 2750 - 3000 mm)	4335 mm

C Minimale	A + 375
C + E Minimale	A + 375 + E (650)
Épaisseur Panneau	40 mm
Ecoinçons	85 mm
Si manuelle: mm restand dans la baie	170 mm
Si motorisee: mm restand dans la baie	0 mm
Rails horizontaux au dessus du linteau (A)	10 mm







	Surface de montage
	Espace necessaire
	Rail moteur au linteau

A	Hauteur de baie	≤ 2500mm
B	Linteau disponible	≥ 160mm
C	Recul	
E	Espace necessaire pour moteur	
G	Poids de la porte	≤ 165kg
W	Surface de la porte	≤ 12,5m ²
X	Largeur de baie	≤ 5000mm

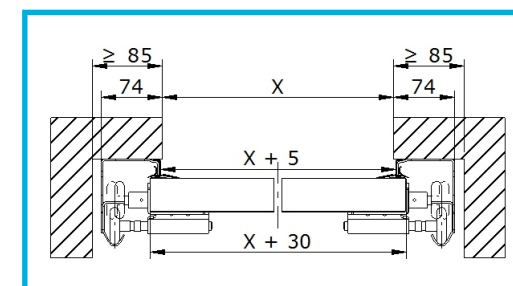
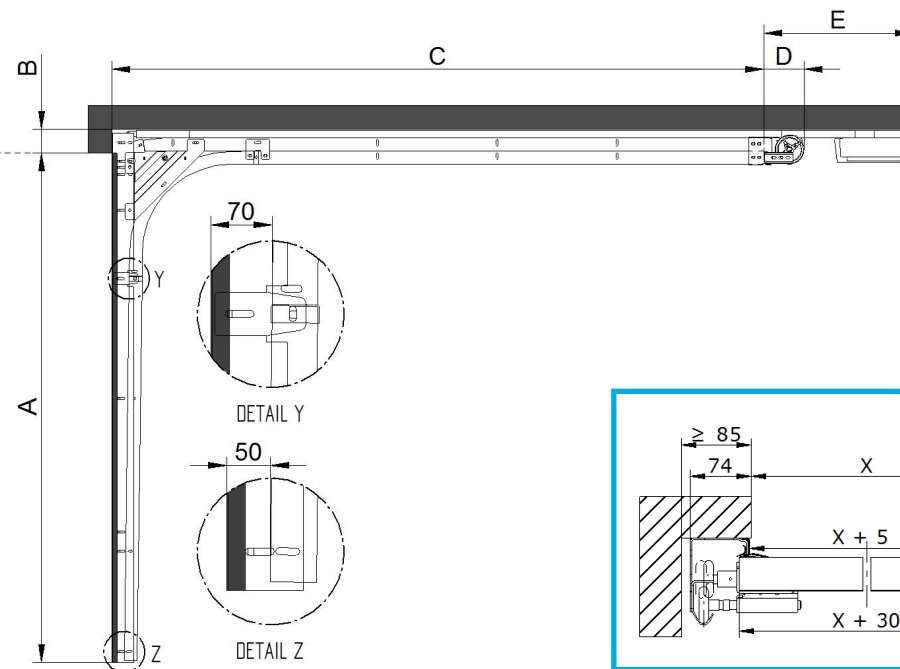
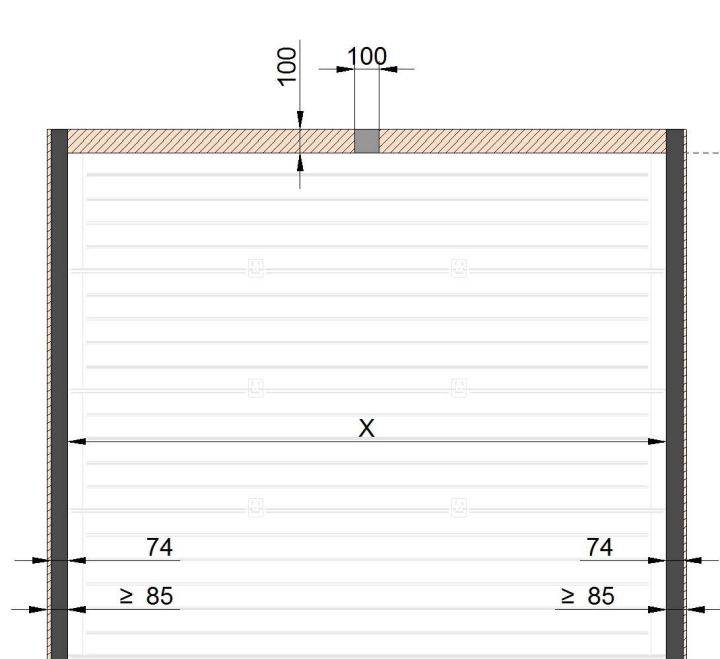
	C	C + E
	2605 mm (A > 2000 - 2125 mm)	3325 mm
	2730 mm (A > 2125 - 2250 mm)	3575 mm
	2855 mm (A > 2250 - 2375 mm)	3575 mm
	2980 mm (A > 2375 - 2500 mm)	3575 mm

C Minimale	A + 375
C + E Minimale	A + 375 + E (650)
Épaisseur Panneau	40 mm
Ecoinçons	85 mm
Si manuelle: mm restand dans la baie	170 mm
Si motorisee: mm restand dans la baie	0 mm
Rails horizontaux au dessus du linteau (A)	10 mm



	Surface de montage
	Espace necessaire
	Rail moteur au linteau

A	Hauteur de baie	≤ 3000mm
B	Linteau disponible	≥ 100mm
C	Recul	
D	Espace necessaire pour ressort	150mm
E	Espace necessaire pour moteur	
G	Poids de la porte	≤ 300kg
W	Surface de la porte	≤ 18m ²
X	Largeur de baie	≤ 6000mm

	C + D	C + E
	2725 + D (A > 2000 - 2125 mm)	3325 mm
	2850 + D (A > 2125 - 2250 mm)	3575 mm
	2975 + D (A > 2250 - 2375 mm)	3575 mm
	3100 + D (A > 2375 - 2500 mm)	4335 mm
	3350 + D (A > 2500 - 2750 mm)	4335 mm
	3600 + D (A > 2750 - 3000 mm)	4335 mm

C + D Minimale	A + 375 + D
C + E Minimale	A + 375 + E (650)

Épaisseur Panneau	40 mm
Ecoinçons	85 mm
Si manuelle: mm restand dans la baie	170 mm
Si motorisee: mm restand dans la baie	20 mm
Rails horizontaux sous le linteau (A)	50 mm

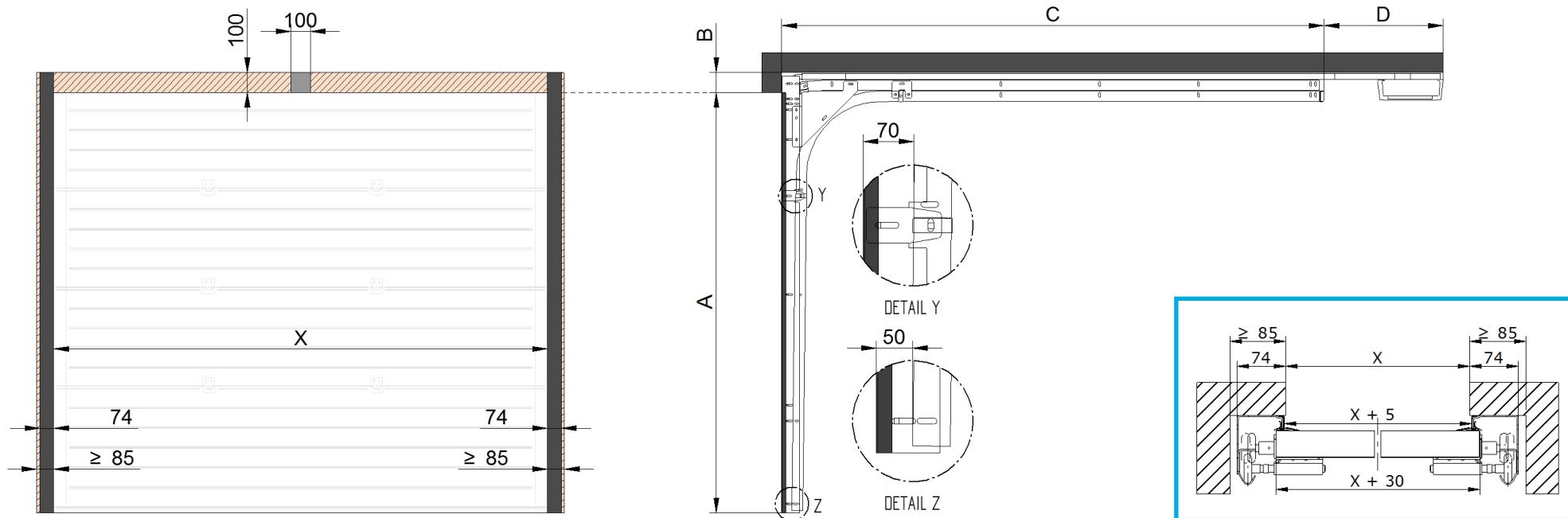

Surface de montage
Espace necessaire
Rail moteur au linteau

A	Hauteur de baie	≤ 2500mm
B	Linteau disponible	≥ 100mm
C	Recul	
E	Espace necessaire pour moteur	
G	Poids de la porte	≤ 100kg
W	Surface de la porte	≤ 8m ²
X	Largeur de baie	≤ 3250mm

	C	C + E
	2725 (A > 2000 - 2125 mm)	3325 mm
	2850 (A > 2125 - 2250 mm)	3575 mm
	2975 (A > 2250 - 2375 mm)	3575 mm
	3100 (A > 2375 - 2500 mm)	4335 mm

C Minimale	A + 375
C + E Minimale	A + 375 + E (650)
Épaisseur Panneau	40 mm
Ecoinçons	85 mm
Si manuelle: mm restand dans la baie	230 mm
Si motorisee: mm restand dans la baie	20 mm
Rails horizontaux sous le linteau (A)	50 mm

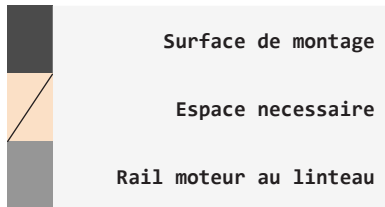
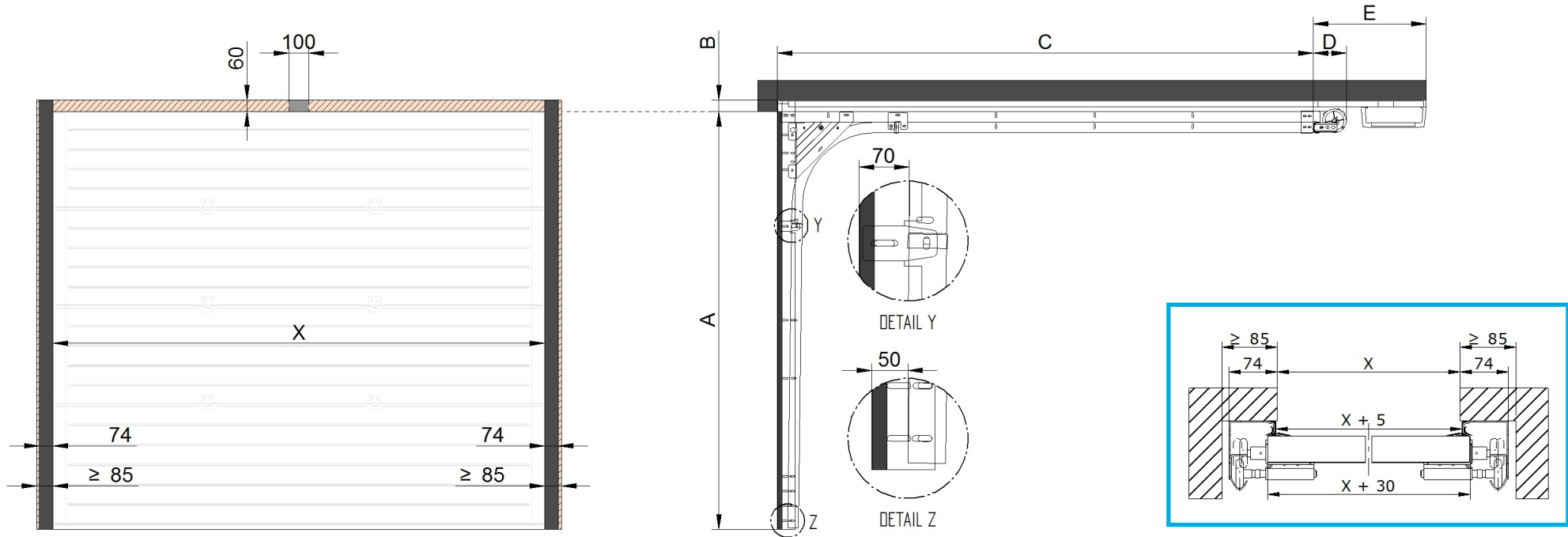

A	Daylight height	≤ 3000mm
B	Hauteur de baie	≥ 60mm
C	Recul	
D	Espace necessaire pour ressort	150mm
E	Espace necessaire pour moteur	
G	Poids de la porte	≤ 300kg
W	Surface de la porte	≤ 18m ²
X	Largeur de baie	≤ 6000mm

	C + D	C + E
	2725 + D (A > 2000 - 2125 mm)	3325 mm
	2850 + D (A > 2125 - 2250 mm)	3575 mm
	2975 + D (A > 2250 - 2375 mm)	3575 mm
	3100 + D (A > 2375 - 2500 mm)	4335 mm
	3350 + D (A > 2500 - 2750 mm)	4335 mm
	3600 + D (A > 2750 - 3000 mm)	4335 mm

C + D Minimale	A + 375 + D
C + E Minimale	A + 375 + E (650)

Épaisseur Panneau	40 mm
Ecoinçons	85 mm
mm restand dans la baie	85 mm
Rails horizontaux sous le linteau (A)	110 mm